

## 363-230-40-S2 Rotary Actuator

### Description

Rotary actuator for adjusting dampers in HVAC installations.

- Running time 150 s / 90°
- Torque 40 Nm
- Nominal voltage 230V AC/DC
- Control 2-/3-point
- Auxiliary switch 2x freely adjustable
- Damper size up to approx. 8 m<sup>2</sup>
- Damper coupling clamp  
∅ 9-18 mm / Ø 9-26 mm



### Technical data

#### Electrical data

<b>Nominal voltage</b>	230V AC/DC, 50/60Hz
<b>Nominal voltage range</b>	85...265 VAC/DC
<b>Power consumption motor (motion)</b>	5.5 W
<b>Power consumption standby (end position)</b>	1.5 W
<b>Wire sizing</b>	10.0 VA
<b>Control</b>	2-/3-point
<b>Feedback signal</b>	-
<b>Auxiliary switch</b>	2 x SPDT (Ag)
<b>Contact load</b>	5 (2.5) A, 250 VAC
<b>Switching point</b>	0...95°
<b>Connection motor</b>	cable 1000 mm, 3 x 0.75 mm <sup>2</sup> (halogen free)
<b>Connection feedback potentiometer</b>	-
<b>Connection auxiliary switch</b>	cable 1000 mm, 6 x 0,75 mm <sup>2</sup> (halogen free)
<b>Connection GUAC</b>	-

### Functional data

<b>Torque</b>	40 Nm
<b>Damper size</b>	up to approx. 8 m <sup>2</sup>
<b>Synchronized speed</b>	±5%
<b>Direction of rotation</b>	selected by switch
<b>Manual override</b>	gearing latch disengaged with pushbutton, self-resetting
<b>Angle of rotation</b>	0°...max. 95° can be limited with adjustable mechanical end stops
<b>Running Time</b>	150 s / 90°
<b>Sound power level</b>	< 45 dB(A)
<b>Shaft coupling</b>	clamp $\diamond$ 9-18 mm / $\varnothing$ 9-26 mm
<b>Position indication</b>	mechanical with pointer
<b>Service life</b>	> 60'000 cycles (0° - 95° - 0°)

### Safety

<b>Protection class</b>	II (double insulation)
<b>Degree of protection</b>	IP 54
<b>EMC</b>	CE (2014/30/EU)
<b>LVD</b>	CE (2014/35/EU)
<b>RoHS</b>	CE (2011/65/EU - 2015/863/EU - 2017/2102/EU)
<b>Mode of operation</b>	Typ 1 (EN 60730-1)
<b>Rated impulse voltage supply / control</b>	4 kV (EN 60730-1)
<b>Control pollution degree</b>	3 (EN 60730-1)
<b>Ambient temperature normal operation</b>	-30°C...+50°C
<b>Storage temperature</b>	-30°C...+80°C
<b>Ambient humidity</b>	5...95% r.H., non-condensing (EN 60730-1)
<b>Maintenance</b>	Maintenance free

### Dimensions/Weight

<b>Dimensions</b>	193 x 96 x 60 mm
<b>Weight</b>	1700 g

**Functionality / Properties**

**Operating mode**

**2 point:**

Connect power supply to wire 1+2, actuator drives to position 1. Is also wire 3 connected to the power supply, actuator drives to position 0.

**3 point:**

Connect power supply to wire 1+2, actuator drives to position 1. Is wire 1+3 connected to the power supply, actuator drives to position 0.

The actuator is overload-proof, requires no limit switches and automatically stops, when the end stop is reached.

**Direct mounting**

Simple direct mounting on the damper shaft with a clamp, protection against rotating with enclosed anti-rotation lock or rather at intended attachment points.

**Manual override**

Manual override with selfresetting pushbutton possible (the gear is disengaged as long as the button is pressed).

**Signaling**

The two integrated auxiliary switches are freely adjustable in the angle of 0 - 95°. There are activated corresponding to the adjusted angle. The damper position can be checked by the mechanical pointer.

**Mode switch**

DIP switch under the case cover  
 R / CW: rotary direction right / clockwise  
 L / CWW: rotary direction left / counter clockwise

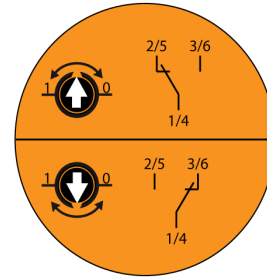

**Connector / Security Note**

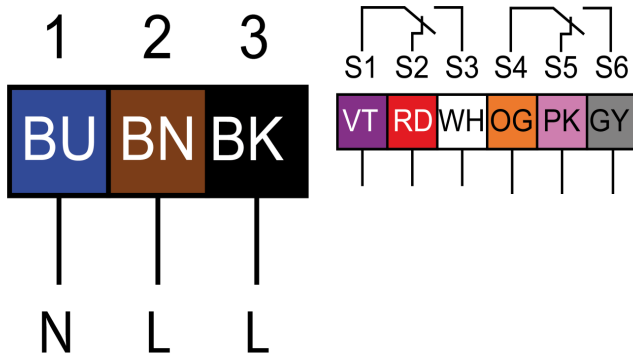

**Safety remarks**

- Caution: power supply voltage!
- The device is not allowed to be used outside the specified field of application, especially in airplanes.
- It may only be installed by suitably trained personnel. Any legal regulations or regulations issued by authorities must be observed during assembly.
- The device may only be opened at the manufacturer's site.
- The device is not allowed to be disposed of as household refuse. All locally valid regulations and requirements must be observed.
- When calculating the required torque, the specifications supplied by the damper manufacturer's (crosssection, design, installation site), and the air flow conditions must be observed.

Copyright by GRUNER AP @2024\_V1. Subject to change in technology and Design.

Technical Drawing

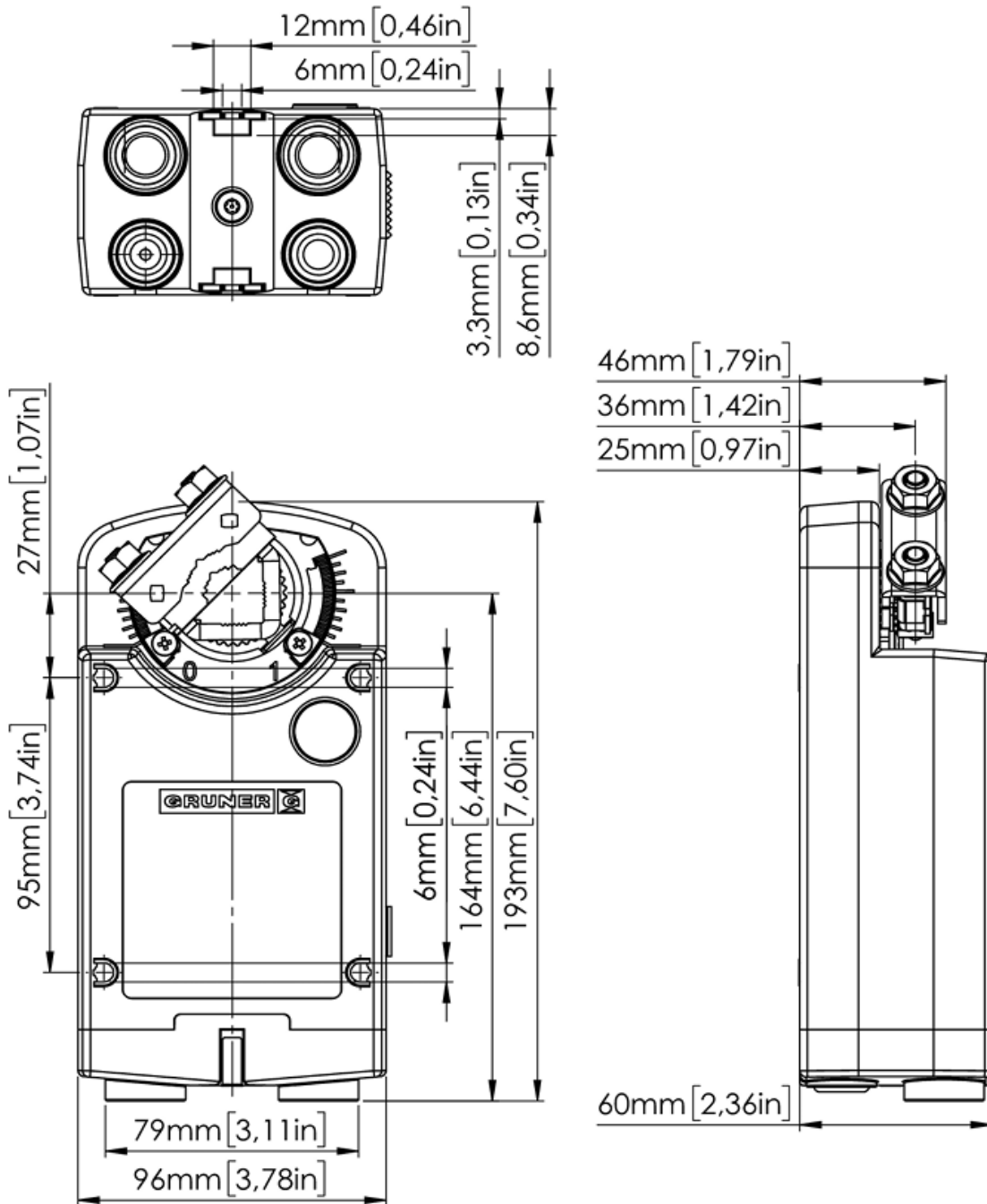

Copyright by GRUNER AP @2024\_V1. Subject to change in technology and Design.