

363C-024-40 Rotary Actuator

Description

Rotary actuator for adjusting dampers in HVAC installations.

- Running time 150 s / 90°
- Torque 40 Nm
- Nominal voltage 24V AC/DC
- Control continuous control (0)2...10 VDC
- Damper size up to approx. 4 m²
- Damper coupling clamp
∅ 9-18 mm / Ø 9-26 mm



Technical data

Electrical data

Nominal voltage	24V AC/DC, 50/60Hz
Nominal voltage range	19...29 VAC/DC
Power consumption motor (motion)	7.0 W
Power consumption standby (end position)	2.0 W
Wire sizing	9.0 VA
Control	continuous control (0)2...10 VDC / Ri > 100 kΩ (0)4...20 mA
Feedback signal	(0)2...10 VDC, max. 5 mA
Auxiliary switch	-
Contact load	-
Switching point	-
Connection motor	cable 1000 mm, 3 x 0.75 mm ² (halogen free)
Connection feedback potentiometer	-
Connection auxiliary switch	-
Connection GUAC	-

Functional data

Torque	40 Nm
Damper size	up to approx. 8 m ²
Synchronized speed	±5%
Direction of rotation	selected by switch
Manual override	gearing latch disengaged with pushbutton, self-resetting
Angle of rotation	0°...max. 95° can be limited with adjustable mechanical end stops
Running Time	150 s / 90°
Sound power level	< 45 dB(A)
Shaft coupling	clamp \varnothing 9-18 mm / \varnothing 9-26 mm
Position indication	mechanical with pointer
Service life	> 60 000 cycles (0°...95°...0°) > 1 000 000 partial cycles (max. ±5°)

Safety

Protection class	III (safety extra-low voltage)
Degree of protection	IP 54
EMC	CE (2014/30/EU)
LVD	CE (2014/35/EU)
RoHS	CE (2011/65/EU - 2015/863/EU - 2017/2102/EU)
Mode of operation	Typ 1 (EN 60730-1)
Rated impulse voltage supply / control	0.8 kV (EN 60730-1)
Control pollution degree	3 (EN 60730-1)
Ambient temperature normal operation	-30°C...+50°C
Storage temperature	-30°C...+80°C
Ambient humidity	5...95% r.H., non-condensing (EN 60730-1)
Maintenance	Maintenance free

Dimensions/Weight

Dimensions	193 x 96 x 60 mm
Weight	1600 g

Functionality / Properties

Operating mode

Connect power supply to wire 1+2 and a reference signal Y to wire 3 in range of (0)2...10 VDC, actuator drives to its specified position. The actual damper position (0...100%) is a feedback signal U on wire 4 for example to share with other actuators. The actuator is overload-proof, requires no limit switches and automatically stops, when the end stop is reached.

Direct mounting

Simple direct mounting on the damper shaft with a clamp, protection against rotating with enclosed anti-rotation lock or rather at intended attachment points.

Manual override

Manual override with self resetting pushbutton possible (the gear is disengaged as long as the button is pressed)

Mode switch

DIP switch under the case cover

Adaption drive

- Actuator power off
- Setting the mechanical end stops
- Actuator power on
- Adaption enable
- Actuator drive to position 0
- Actuator drive to position 1
- Adaption disable, if desired angular range reached or rather if actuator reached endstop
- "Y" refers to the measured angular range

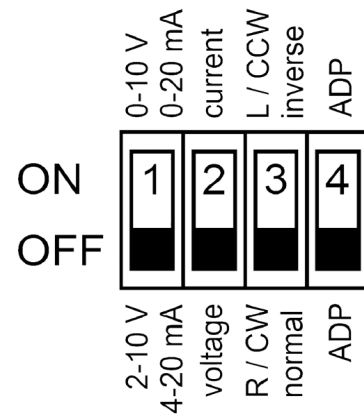

Connector / Security Note

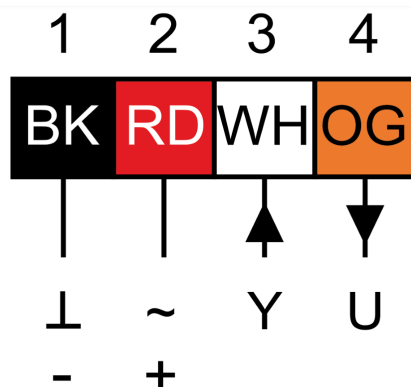

Safety remarks

- Connect via safety isolation transformer!
- The device is not allowed to be used outside the specified field of application, especially in airplanes.
- It may only be installed by suitably trained personnel. Any legal regulations or regulations issued by authorities must be observed during assembly.
- The device may only be opened at the manufacturer's site.
- Cables must not be removed from the device.
- The cable of this actuator cannot be replaced. If the cable is damaged, the actuator should be scrapped.
- The device is not allowed to be disposed of as household refuse. All locally valid regulations and requirements must be observed.
- When calculating the required torque, the specifications supplied by the damper manufacturer's (cross-section, design, installation site), and the air flow conditions must be observed.

Technical Drawing

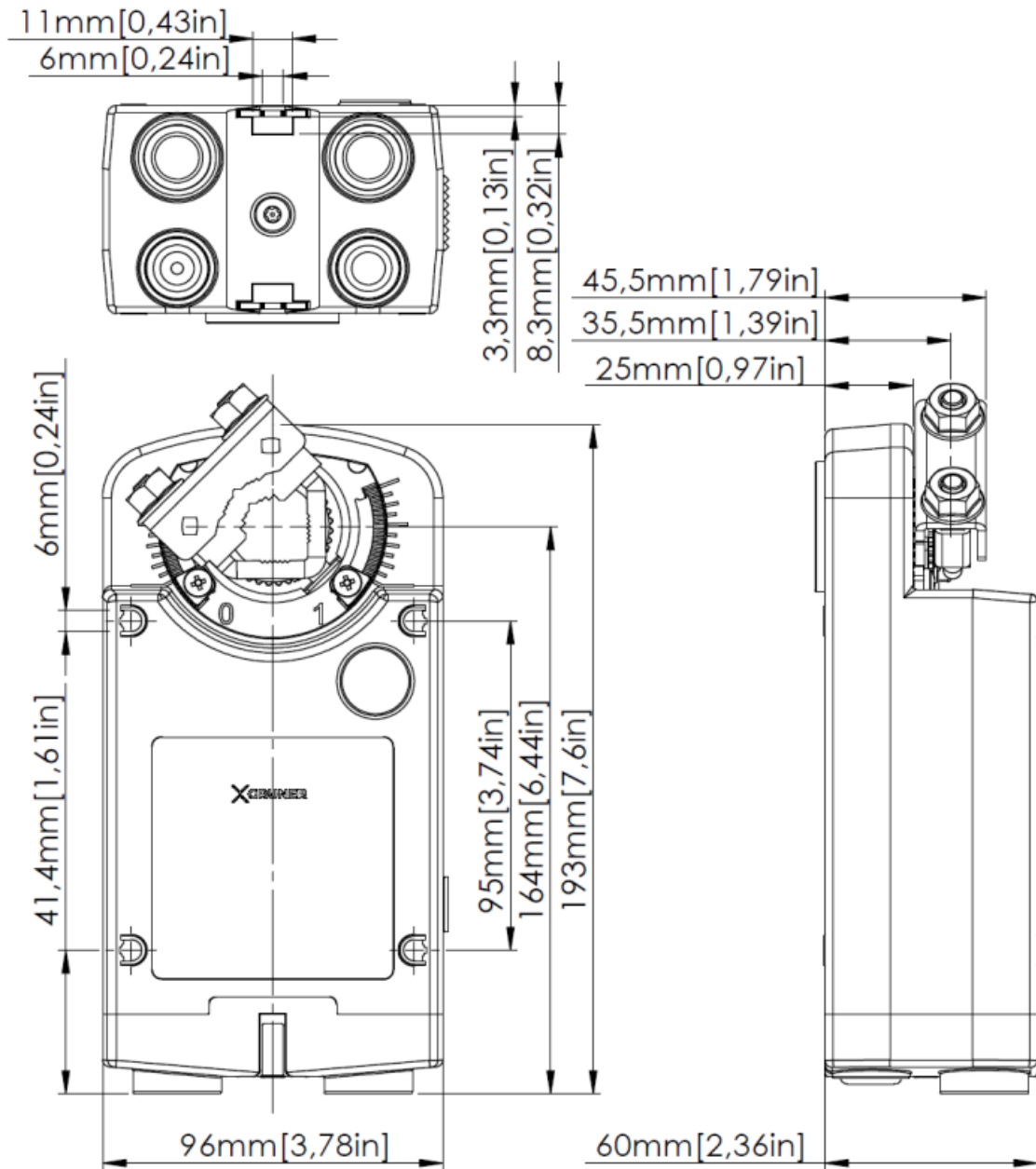

Copyright by GRUNER AP @2024_V1. Subject to change in technology and Design.